

A Field Deployable Imaging Neutron Detector (FIND) for SNM

Jason S. Legere¹, Peter F. Bloser¹, Amanda C. Madden³, Christopher M. Bancroft¹, James M. Ryan¹, Mark L. McConnell^{1,2}, Colin Frost¹, Sonya S. Smith¹, Richard Kroeger⁴, Nathan Paradis⁴, John Gaidos¹, Kevin Mello²

¹Space Science Center, University of New Hampshire, Durham, NH 03824 USA

²Southwest Research Institute—Earth, Oceans, and Space, Durham, NH 03824 USA

³Los Alamos National Laboratory, Los Alamos, NM 87545 USA

⁴Space and Naval Warfare Systems Command, SSC Pacific, San Diego, CA 92110 USA

Abstract

Neutron detection is of particular interest for nuclear or radiological material identification for security and proliferation deterrence, as well as for nuclear waste detection and monitoring. We present a concept for a Field-Deployable Imaging Neutron Detector (FIND) based on modern, commercially available detector technology that is compact, low-power, low-mass, and rugged. Individual detector cells are composed of plastic scintillator with pulse-shape discrimination (PSD) ability read out by arrays of silicon photomultipliers (SiPMs). A double-scatter neutron camera is formed by two layers of such detector cells. The compactness, ruggedness, and low weight of this technology allows these layers to be easily transported in standard portable containers for rapid deployment and assembly in the field. We describe the FIND instrument concept and initial tests of detector cell performance.

FIND Design

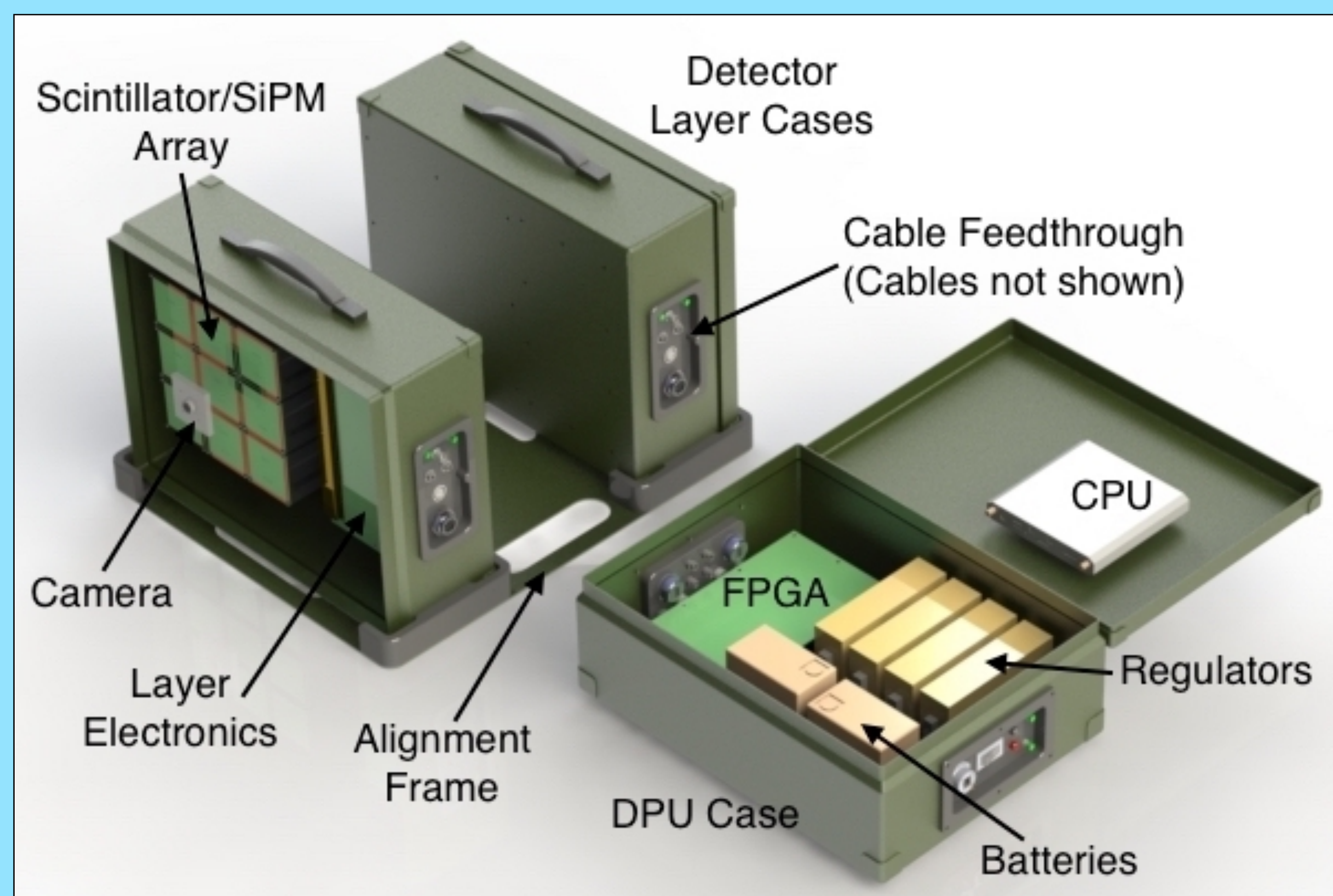

FIND Construction

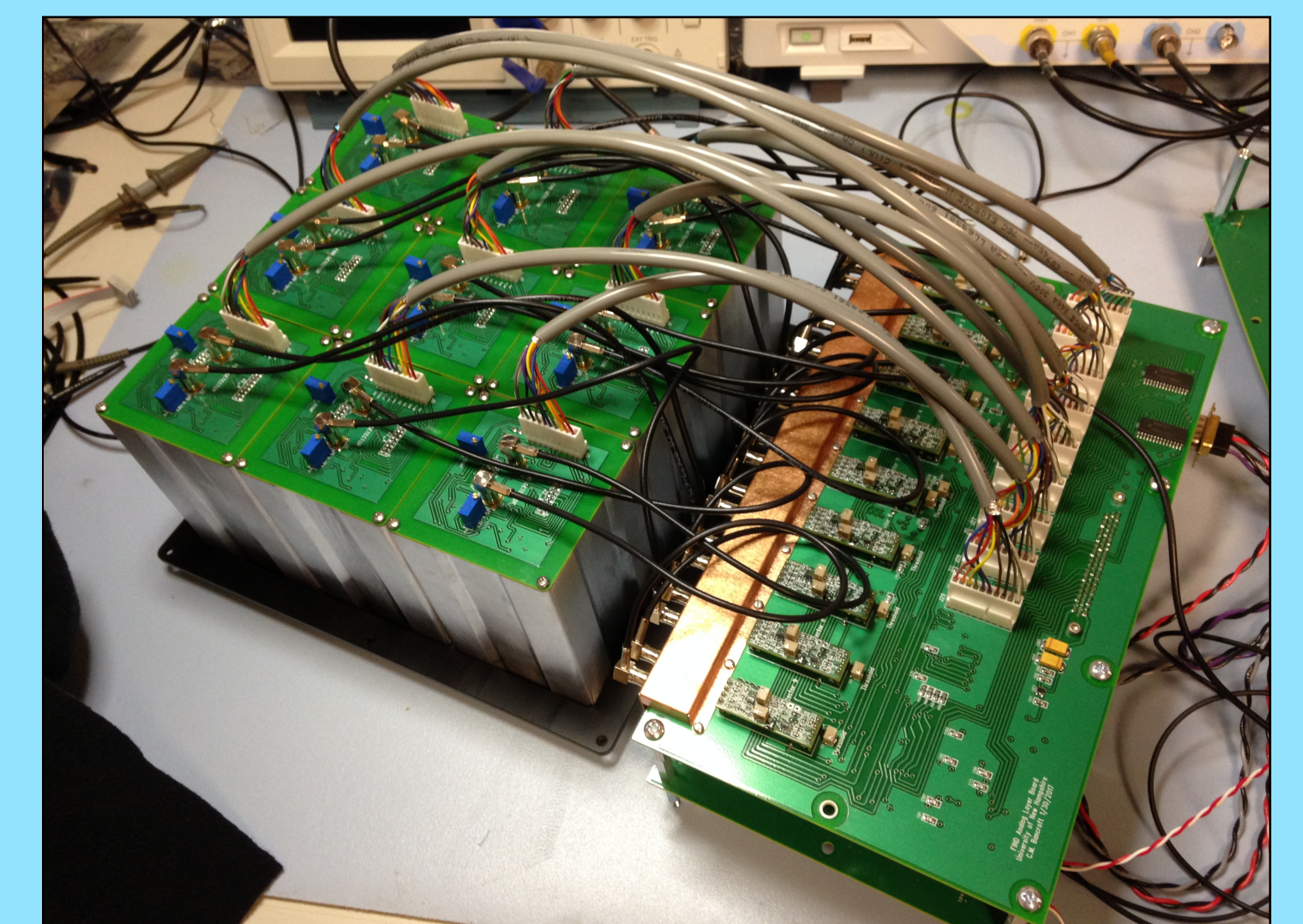
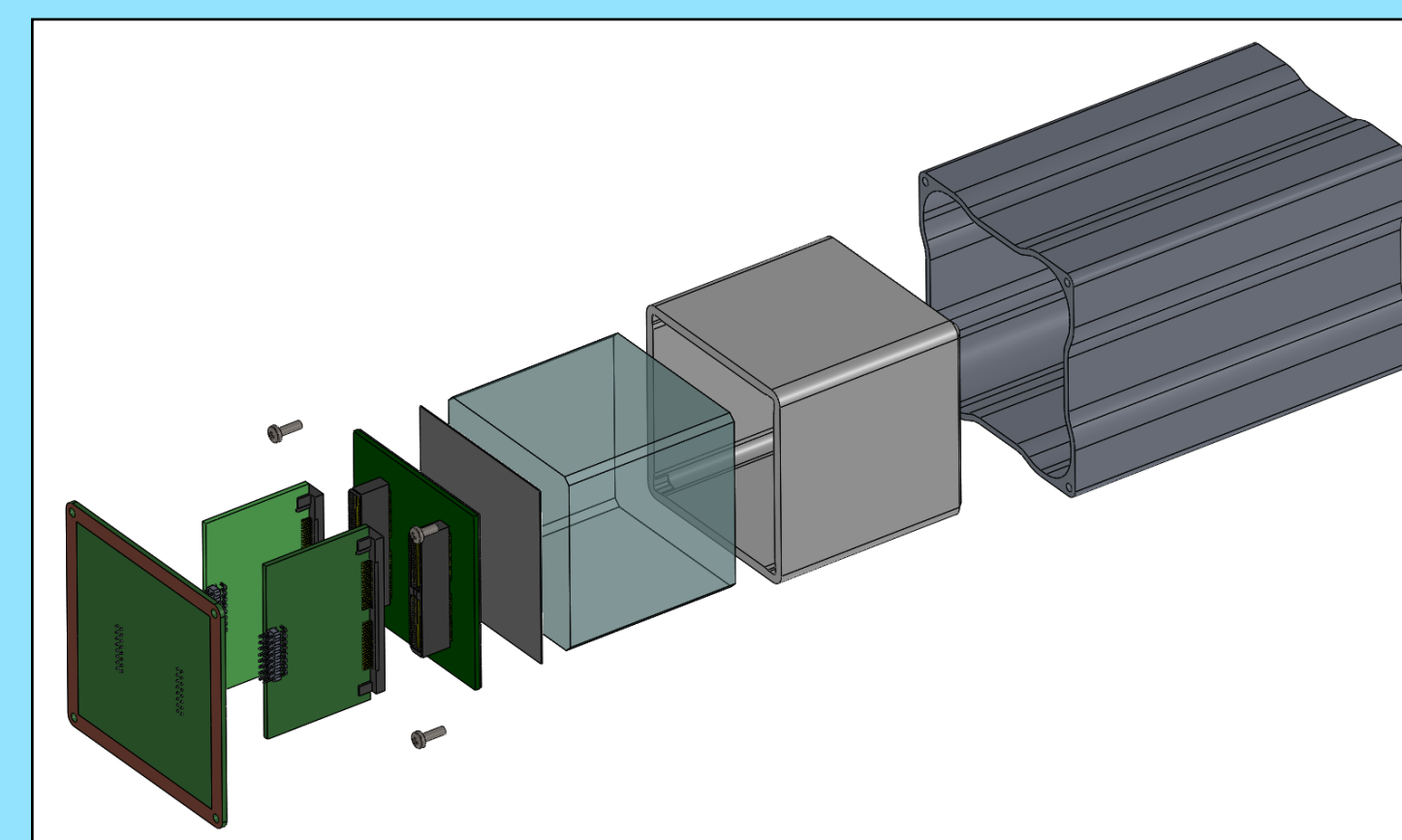

- Detector cells constructed with plastic scintillator and SiPM arrays

- Layer arrays contain nine detector cells with discrete readout

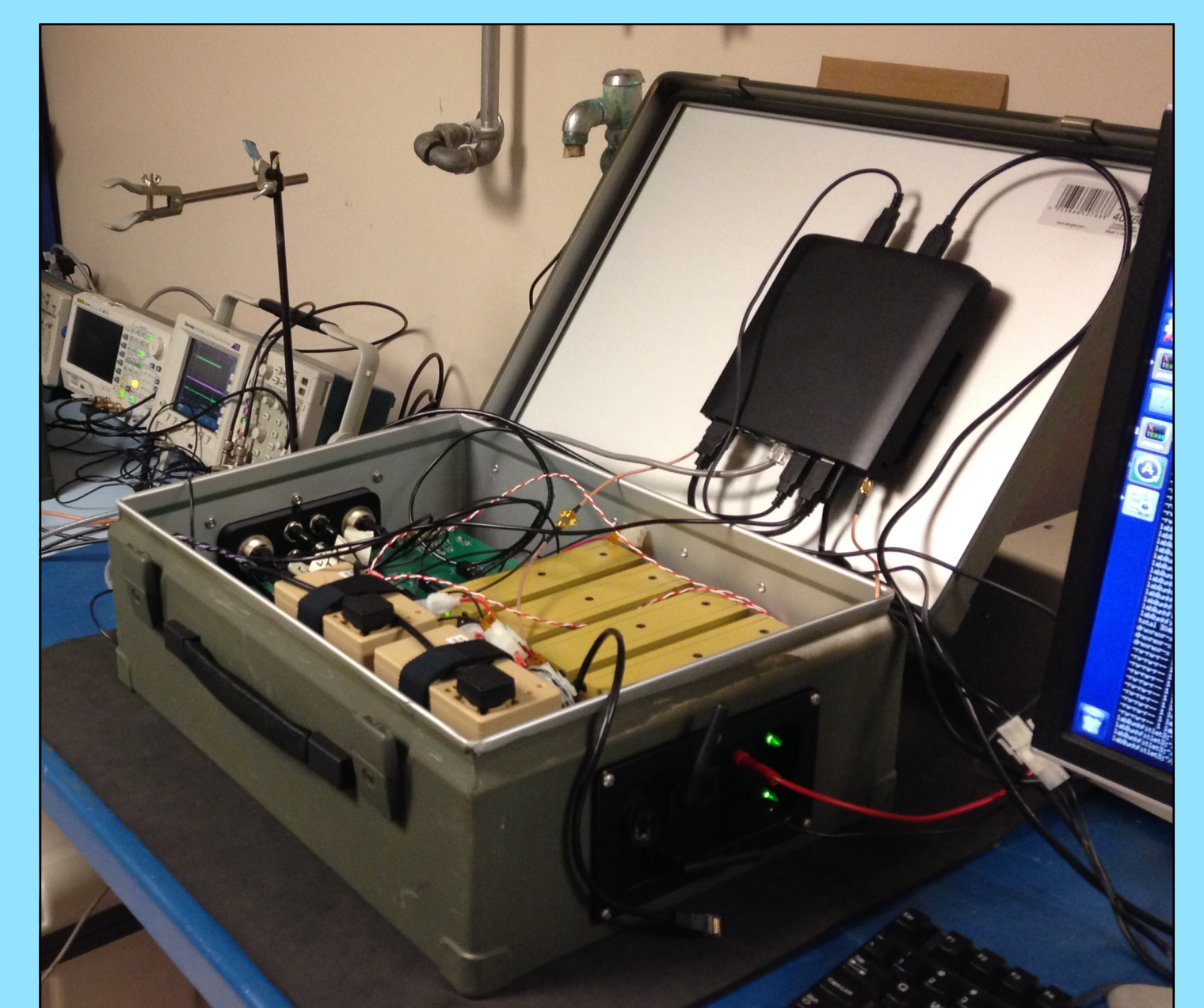
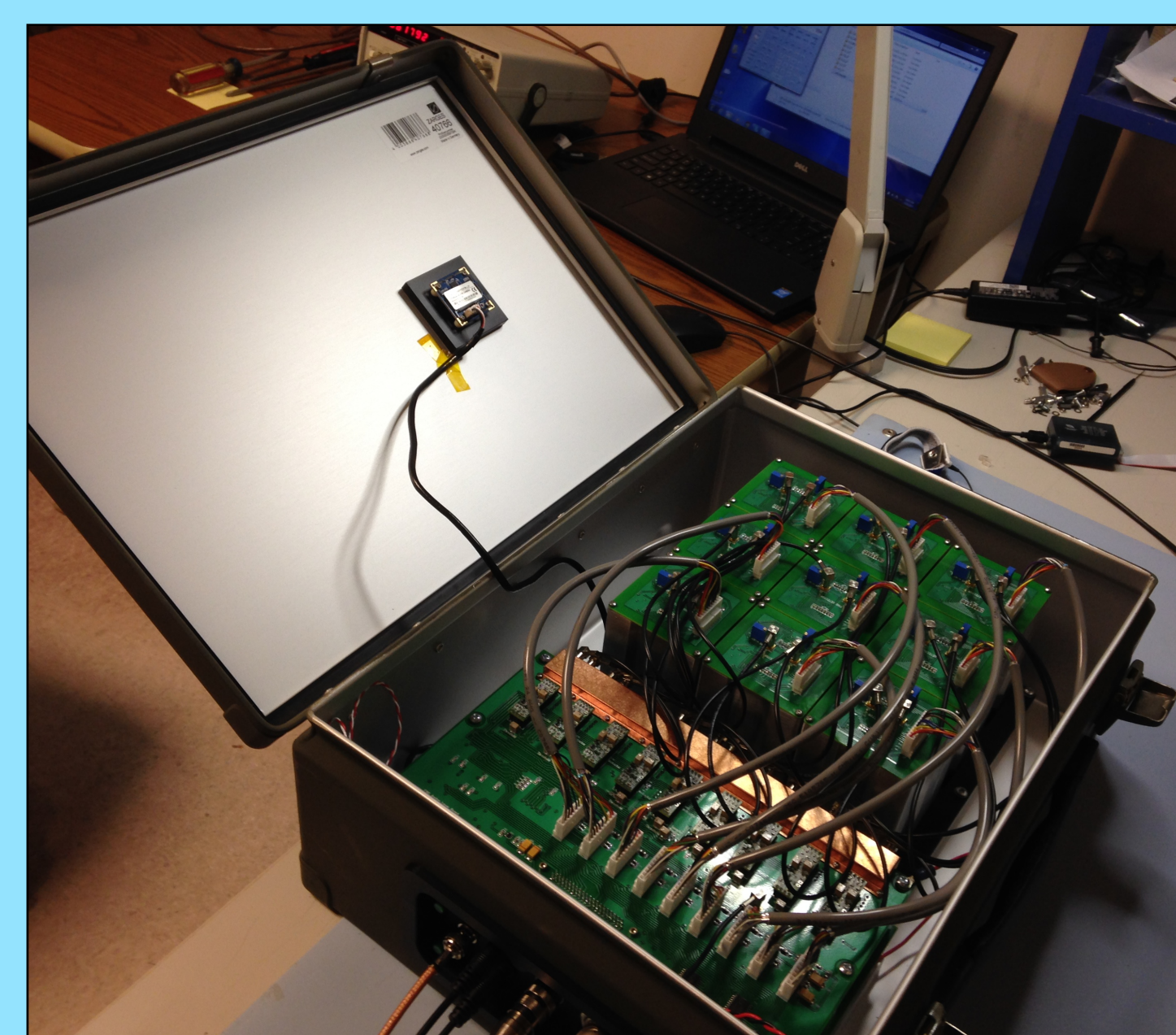

- Layer cases weigh 25 lb and are independently controlled by the DPU case

- The DPU case provides power and control of the layer cases. It also interfaces to the GUI

Technique

- Detect multiple n-p scattering in position-sensitive detector layers made up of individual scintillator cells
- Measure: positions, energy deposits, time-of-flight, pulse shape
- Apply n-p scatter kinematics to compute incident particle energy and direction
- Apply Compton Scattering kinematics for gamma-ray imaging

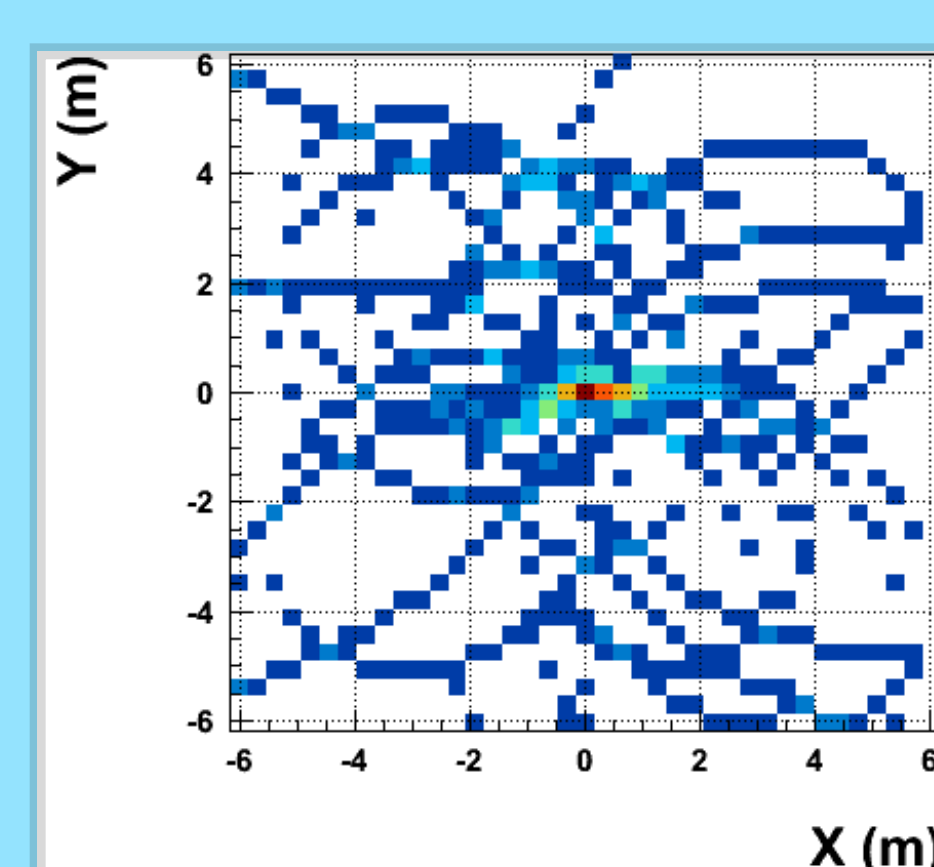
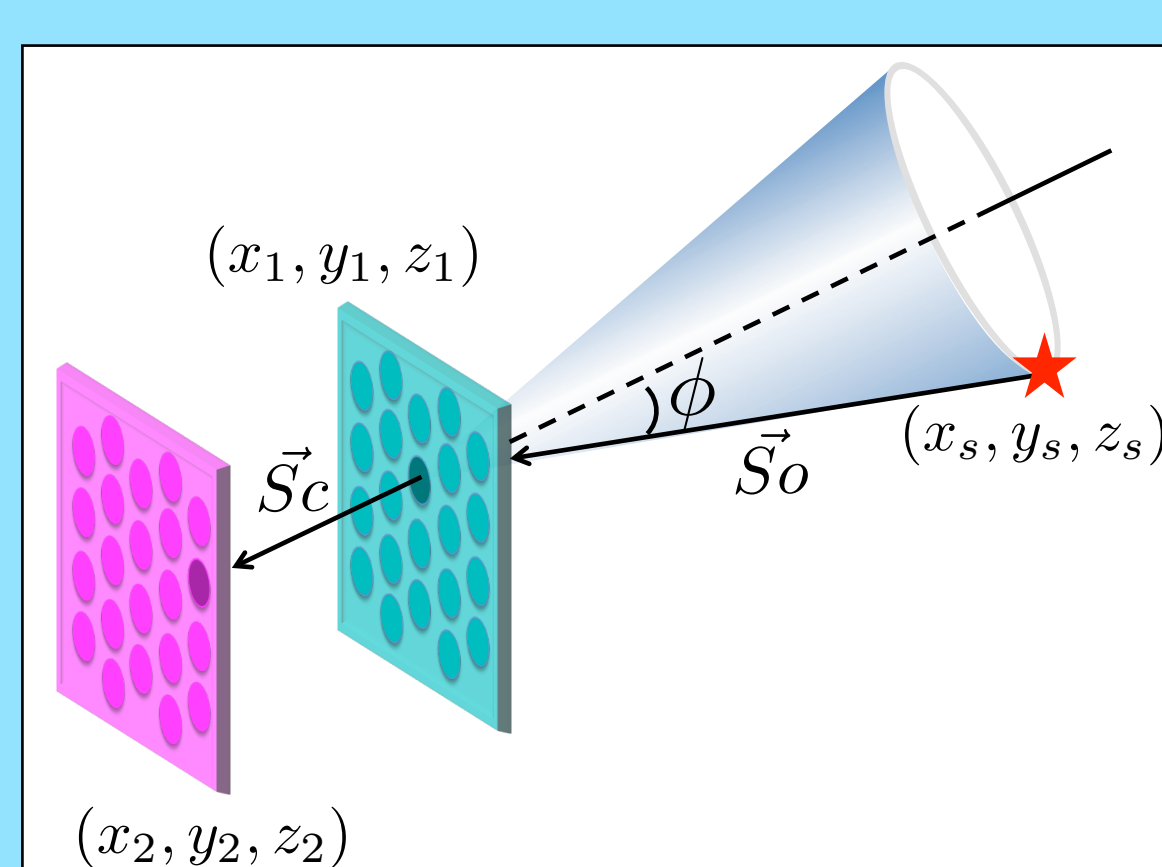

20 events

- Discriminate between neutron and gammas using TOF & PSD

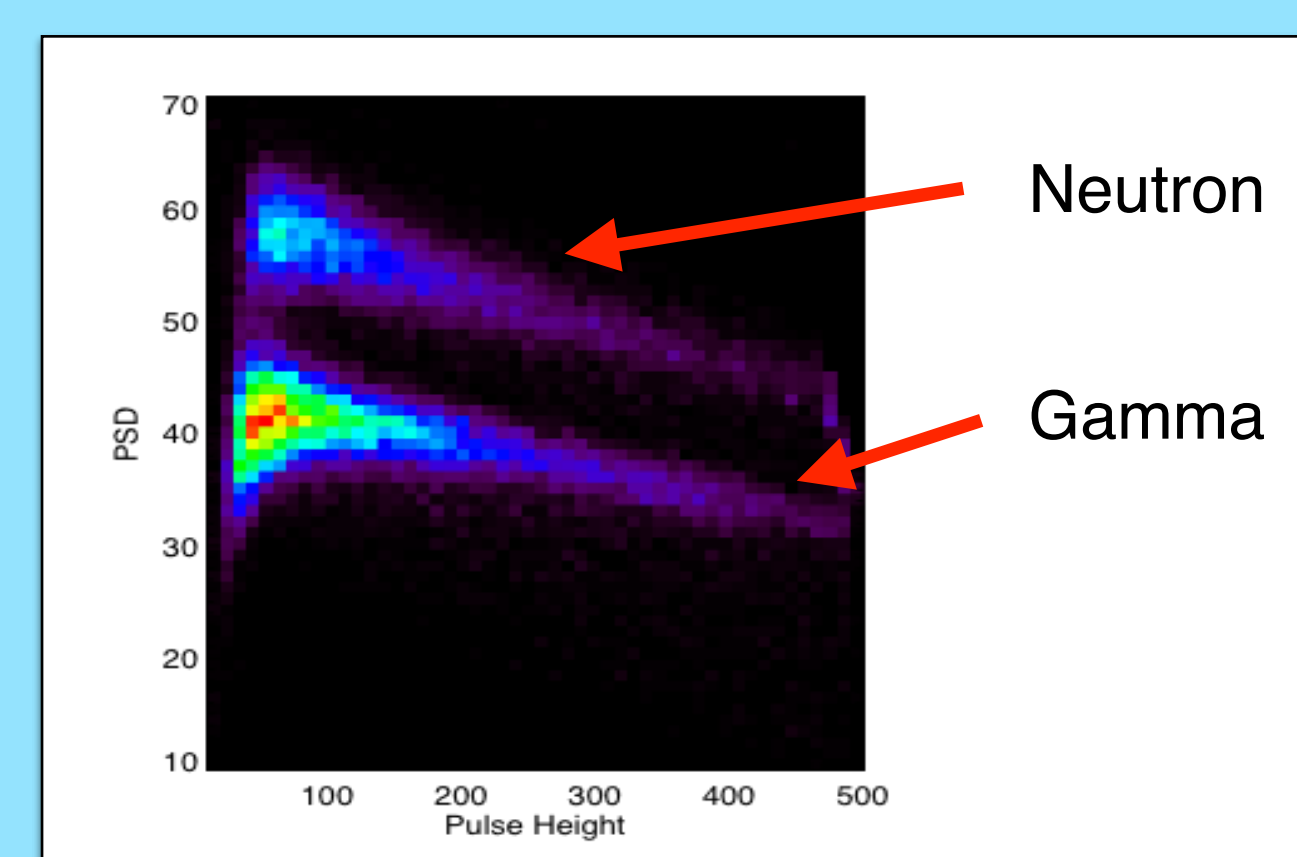
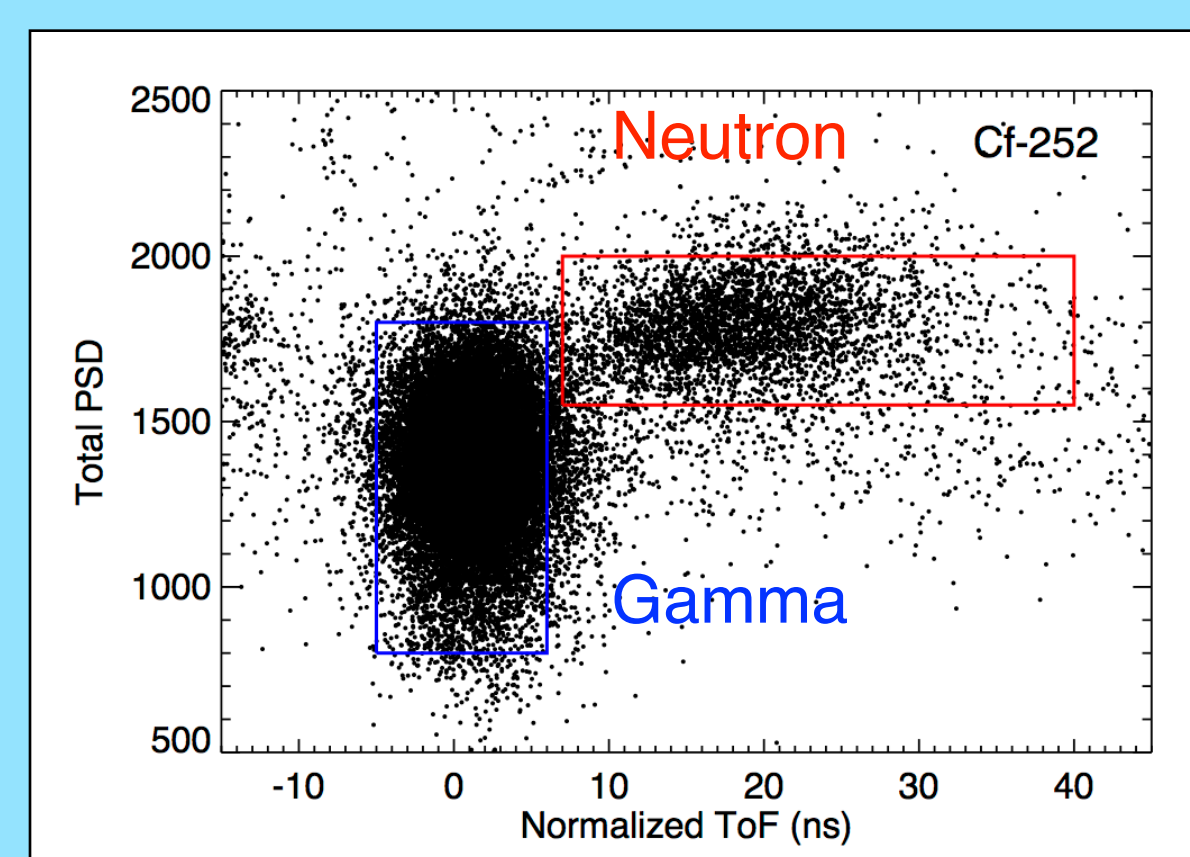

- Constructed image is overlaid on camera image for source location
- Display is done through a Web-page-based GUI via WiFi

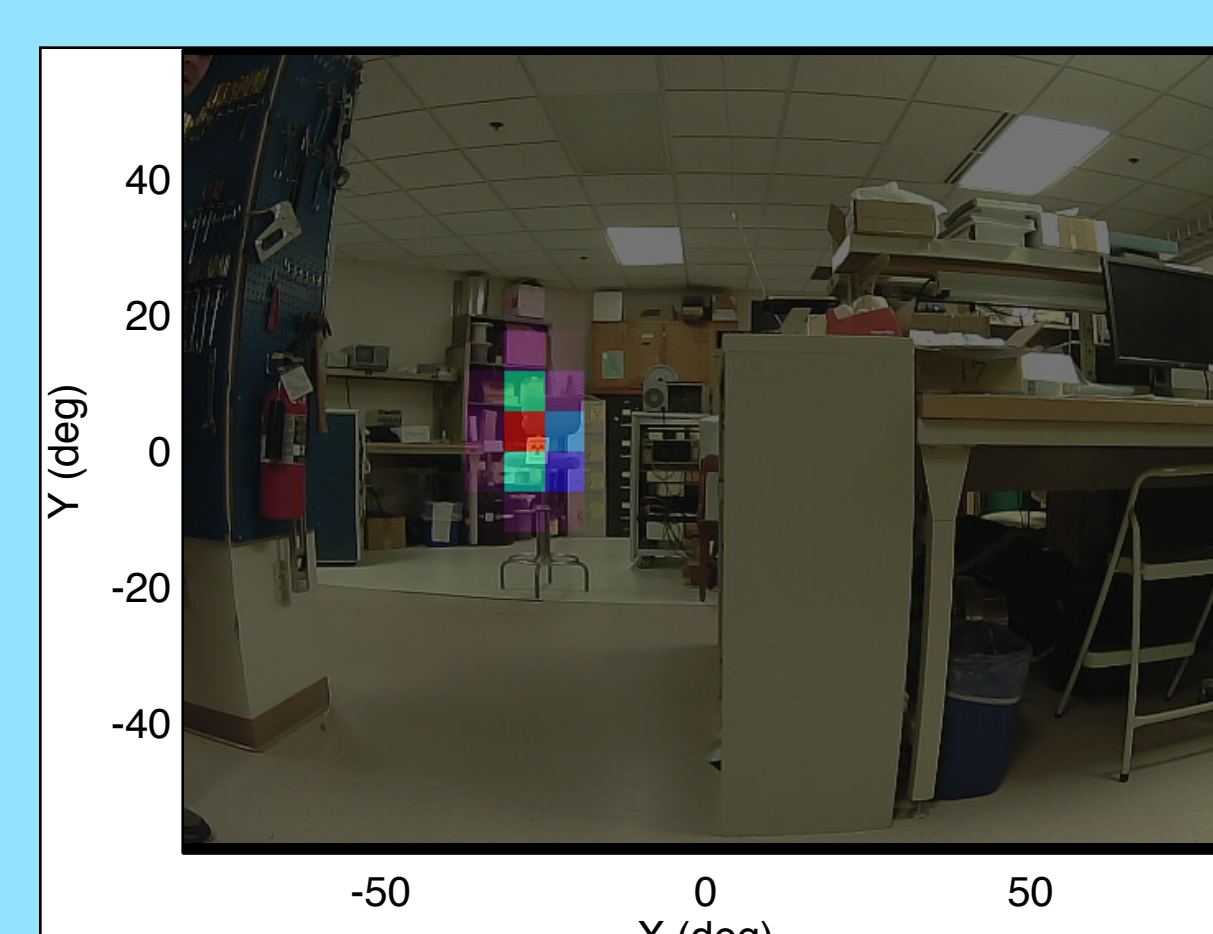
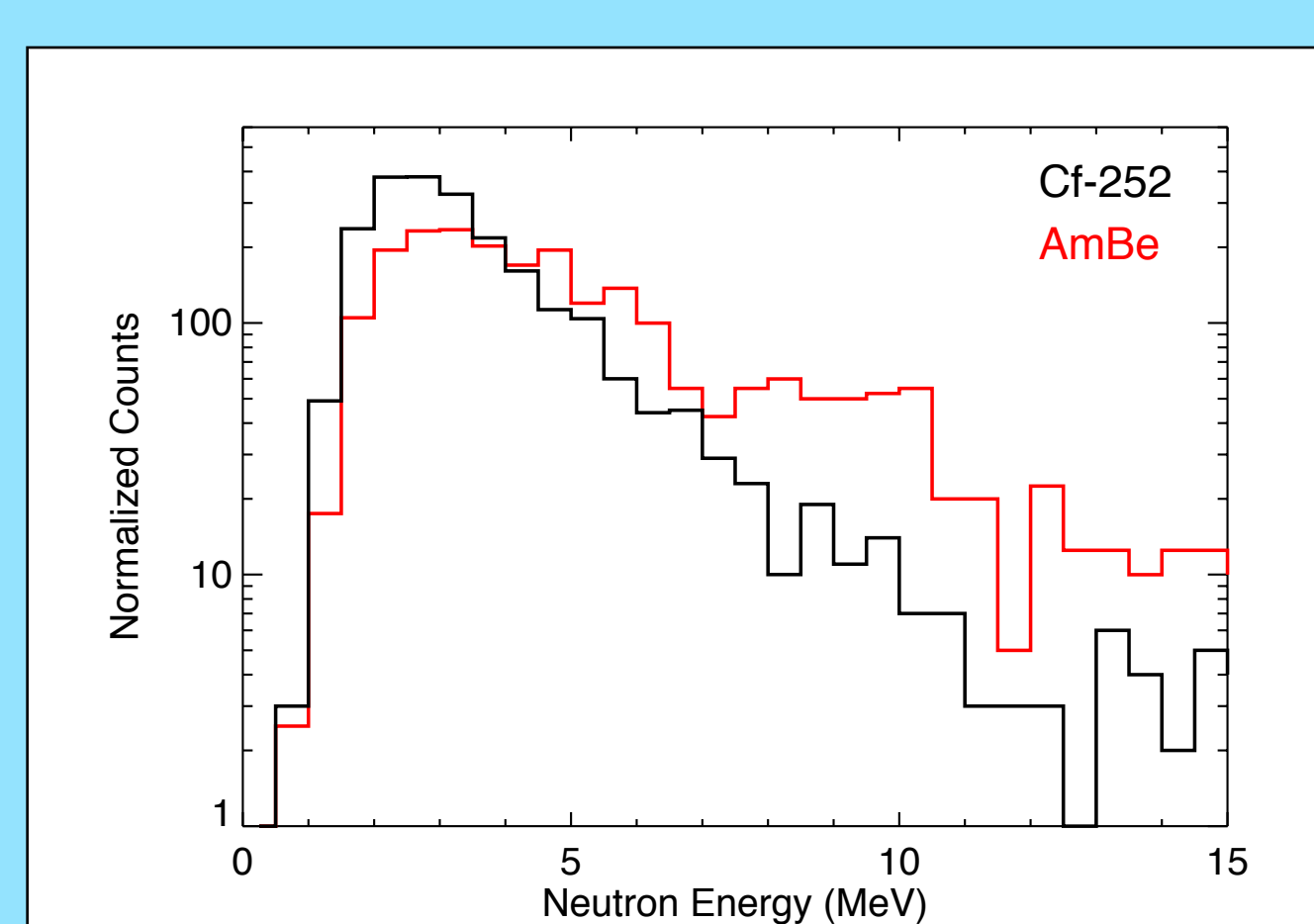

Planned Improvements

- Replace Plastic PSD Scintillator with brighter Stilbene Crystals
- Replace C-series array with smaller area J-series arrays

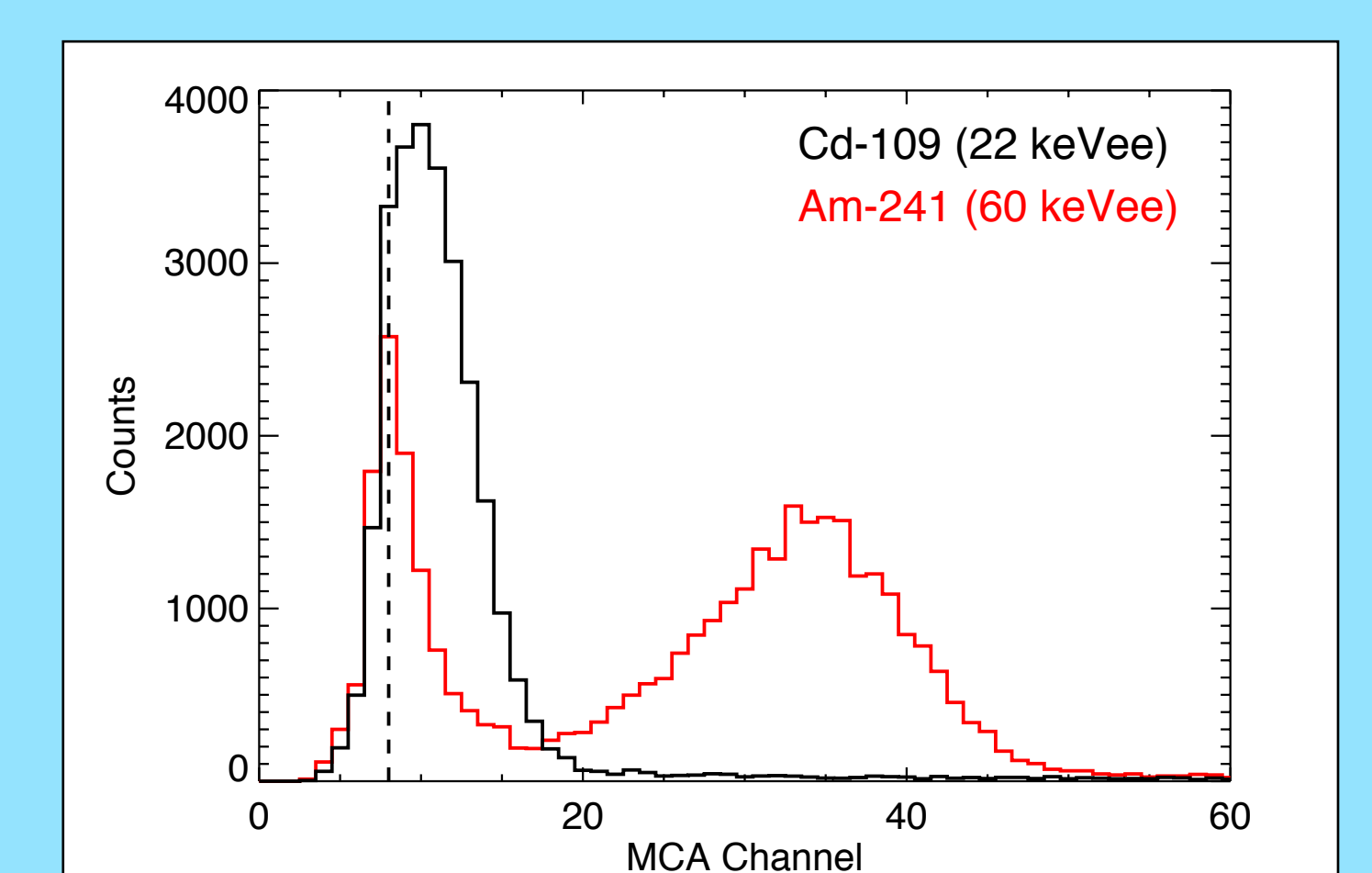
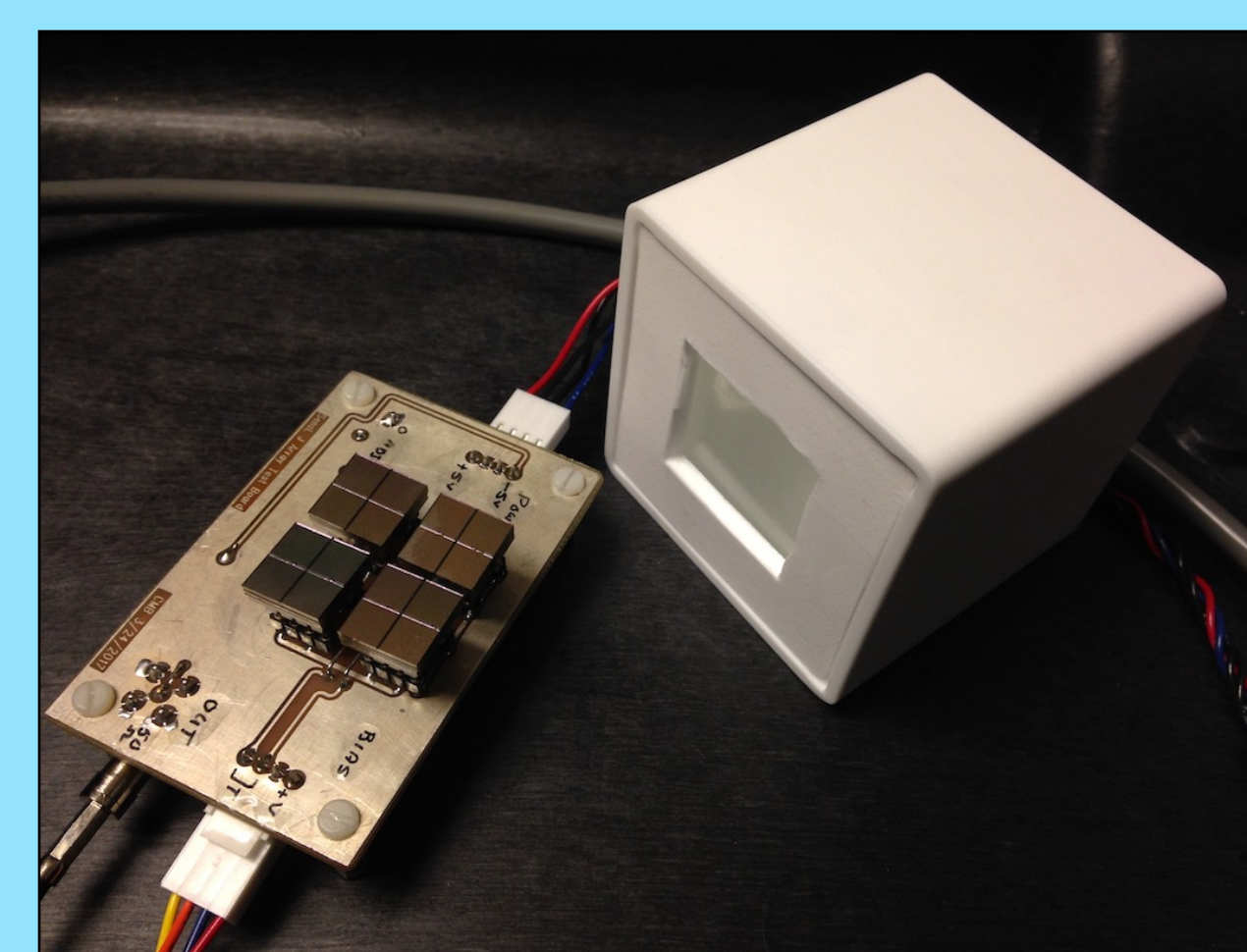

- Reduced Volume and Mass
- Lower Power
- Better Timing
- Lower Threshold
- Higher Efficiency

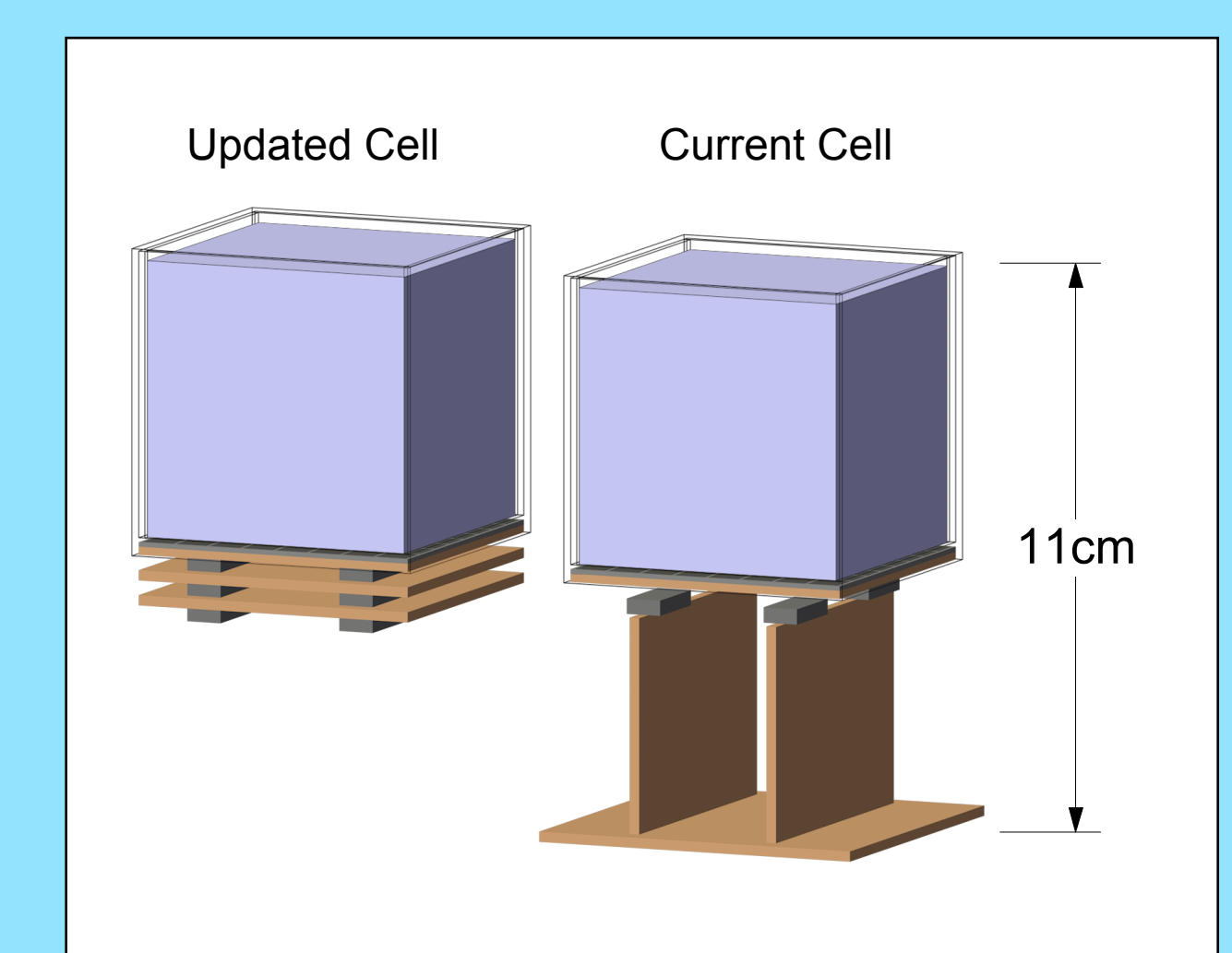

Approved for public release; distribution is unlimited.

